

# *the Smart Oven® Pro*

Instruction Book - BOV820EX



# **Breville®**



## Contents

2	Breville Recommends Safety First	
8	Components	
10	Quick Start Guide	
12	Functions	
	- Operating your oven	12
	- GRILL function	13
	- TOAST function	14
	- CRUMPET function	15
	- BAKE function	16
	- ROAST function	17
	- PIZZA function	18
	- COOKIES function	19
	- REHEAT function	20
	- WARM function	21
	- SLOW COOK function	21
	- Replacing the oven light	23
24	Care & Cleaning	
26	Troubleshooting	

## BREVILLE RECOMMENDS SAFETY FIRST

At Breville we are very safety conscious. We design and manufacture consumer products with the safety of you, our valued customer, foremost in mind. In addition we ask that you exercise a degree of care when using any electrical appliance and adhere to the following precautions.

## IMPORTANT SAFEGUARDS

### READ ALL INSTRUCTIONS BEFORE USE AND SAVE FOR FUTURE REFERENCE

- Remove and safely discard any packing materials and promotional labels before using the oven for the first time.
- To avoid choking hazard for young children, remove and safely dispose the protective cover fitted on the power plug.
- Do not use the appliance near the edge of a benchtop or table. Ensure the surface is stable, level, heat-resistant and clean.
- Do not use on a cloth-covered surface, near curtains or other flammable materials.

- A fire may occur if the oven is covered or touches flammable material, including curtains, draperies, walls, and the like, when in operation.
- Do not use the appliance on (or close to) a hot gas or electric burner, or where it could touch a heated oven or surface.
- Do not let the power cord hang over the edge of a table or counter, or touch hot surfaces.
- To avoid electric shock, do not immerse the cord, plug or motor base in water (or other liquids).
- When operating the oven, keep a minimum distance of 10cm of space on both sides of the appliance and 15cm above.
- The temperature of accessible surfaces may be high when the appliance is operating.
- Do not touch hot surfaces. To avoid burns, use extreme caution when removing pans, dishes and accessories such as the included grilling rack and baking pan, that contain hot oil or other hot liquids.
- Do not lay cooking utensils, baking pans or dishes on the glass door.
- Do not leave the door standing open for extended periods of time.
- Do not store any item on top of the oven when in operation except those described on page 22 of this book.
- Do not place cardboard, plastic, paper, or other flammable materials in the oven.
- Do not cover crumb tray or any part of the oven with metal foil. This will cause overheating of the oven.

- Caution should be exercised when using pans and dishes constructed of materials other than metal. Ensure pans and dishes are oven safe before using in the oven.
- Caution should be exercised when using lids in the oven, as pressure build up in a covered pan or dish may cause hot ingredients to expel or the dish to crack. Do not place sealed or airtight containers in the oven.
- Oversized foods and metal utensils must not be inserted in the oven as they may create fire or risk of electric shock.
- The use of accessories and attachments not recommended or supplied with this oven may cause injuries.
- This appliance is for household use only. Do not use in any type of moving vehicles. Do not use the appliance outdoors, or for anything other than its intended use. Misuse can cause injury.
- If the appliance is to be: left unattended, cleaned, moved, assembled or stored, always switch the unit off and unplug the cord from the power outlet and allow to cool completely.
- Do not clean with metal scouring pads. Pieces can break off the pad and touch electrical parts, creating a risk of electric shock.

- The appliance can be used by children aged from 8 years and above and persons with reduced physical, sensory or mental capabilities, or lack of experience and knowledge, if they have been given supervision or instruction concerning use of the appliance in a safe way and understand the hazards involved.
- Children shall not play with the appliance.
- Cleaning and user maintenance shall not be made by children unless they are older than 8 and supervised.
- Keep the appliance and its cord out of reach of children less than 8 years.
- It is recommended to regularly inspect the appliance. To avoid a hazard do not use the appliance if power cord, power plug or appliance becomes damaged in any way. Return the entire appliance to the nearest authorised Breville Service Centre for examination and/or repair.
- The appliance is not intended to be operated by means of external timer or separate remote control system.

# SPECIFIC INSTRUCTIONS FOR BOV820EX

- We recommend the oven is operated on a dedicated circuit separated from other appliances. Consult a licensed and qualified electrician if you are unsure.
- To turn off the oven, press the START/CANCEL button on the control panel. The oven is off when the button backlights turns off.
- Regularly clean the crumb tray. To clean the crumb tray:
  - Turn OFF the oven,
  - Allow the oven to cool completely and then remove the power cord from the power outlet.
  - Remove the crumb tray and clean with warm soapy water.
  - Dry the tray completely before inserting it securely back in place.

## WARNING

To reduce the risk of FIRE, ELECTRIC SHOCK, EXPOSURE TO EXCESSIVE UV RADIATION, OR INJURY TO PERSONS:

- Always unplug the oven and let all parts (including the bulb housing, glass cover and enclosure) cool completely before replacing bulb.
- Only use a 25 Watt, 220–240V, G9 type oven bulb.
- Always use a soft cloth when handling the bulb and do not directly touch the surface as oil from your skin can damage the bulb.
- Do not look directly at a glowing bulb.
- Do not remain in the light if skin feels warm.
- Keep bulb away from materials that may burn.
- The bulb gets hot quickly. Only ever use the light button to turn on the light.

- Do not operate the light if the bulb housing, glass cover, UV filter or enclosure are missing or damaged.



The symbol shown indicates that this appliance should not be disposed of in normal household waste. It should be taken to a local authority waste collection centre designated for this purpose or to a dealer providing this service. For more information, please contact your local council office.



**Hot Surfaces**  
Do Not Touch

This symbol indicates, temperature of accessible surfaces may be high when the appliance is operating and for some time after use.

**FOR HOUSEHOLD USE ONLY**  
**SAVE THESE INSTRUCTIONS**



## Components

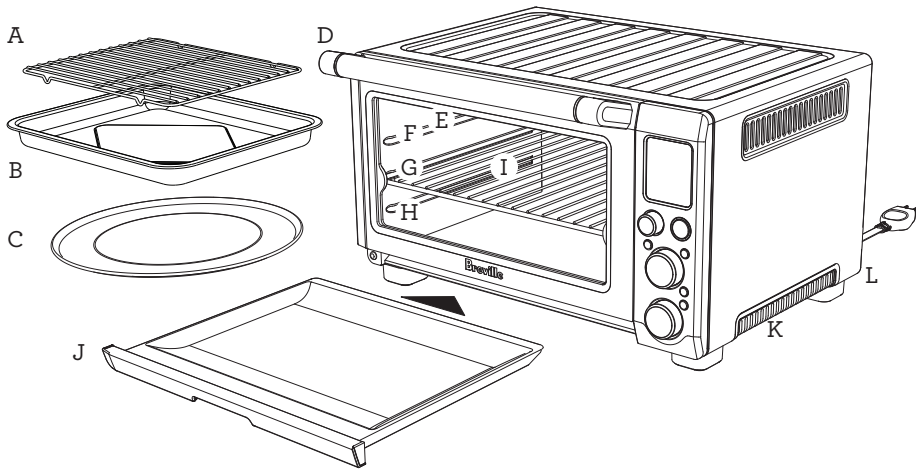

- A. Baking rack
- B. 28 x 30cm enamel baking pan
- C. 28cm non-stick pizza pan
- D. Door handle
- E. Oven light
- F. Top rack height position:  
GRILL function.
- G. Middle rack height position:  
TOAST, Crumpet, PIZZA and  
COOKIES functions.
- H. Bottom rack height position:  
BAKE, ROAST, REHEAT, WARM and  
SLOW COOK functions.
- I. Wire rack
- J. Crumb tray
- K. Ventilation slots
- L. Breville Assist® Plug



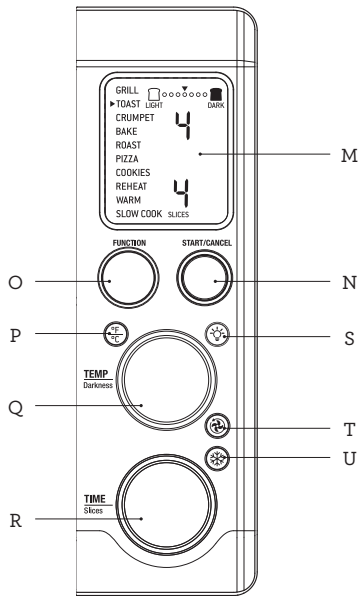





Accessories sold separately:



**Bamboo Cutting Board**  
Part No: BOV800CB

- M. LCD screen
- N. START/CANCEL button
- O. FUNCTION dial
- P.  TEMPERATURE conversion button
- Q. TEMPERATURE dial/toast and crumpet darkness control
- R. TIME dial/toast and crumpet slice selection
- S.  OVEN LIGHT button
- T.  CONVECTION button
- U.  FROZEN FOODS button



## Quick Start Guide

This Quick Start Guide is designed for first time use.

For safety and more information, refer to rest of the Instruction Booklet.

### PREPARING THE OVEN

In order to remove any protective substances on the heating elements, it is necessary to run the oven empty for 15 minutes. Ensure the area is well ventilated as the oven may emit vapours. These vapours are safe and are not detrimental to the performance of the oven.

1. Remove and safely discard any packing material, promotional labels and tape from the oven.
2. Remove the crumb tray, wire rack, grilling rack, baking pan and pizza pan from the polyfoam packaging. Wash them with a soft sponge in warm, soapy water then rinse and dry thoroughly.
3. Wipe the interior of the oven with a soft, damp sponge. Dry thoroughly.
4. Place the oven on a flat, dry surface. Ensure there is a minimum distance of 10cm of space on both sides of the appliance and 15cm above.
5. Insert the crumb tray into the oven.
6. Unwind the power cord completely and insert the power plug in to a grounded power outlet.
7. The oven alert will sound and the LCD screen will illuminate. The function options will appear with an indicator on the BAKE setting.

8. Turn the FUNCTION dial to the right until the indicator reaches the PIZZA function.

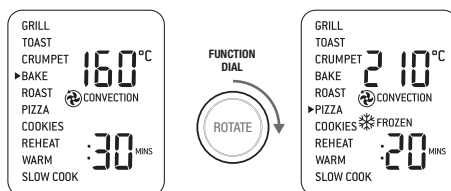

9. Press the START/CANCEL button. The button backlight will illuminate red, the LCD screen will illuminate orange and the oven alert will sound.
10. The LCD screen will indicate a blinking 'PREHEATING'. Once the oven has reached the set temperature, the temperature alert will sound.
11. The timer will be displayed and automatically begin to count down.
12. At the end of the cooking cycle, the oven alert will sound, the START/ CANCEL button backlight will go out and the LCD screen will illuminate blue.
13. The oven is now ready to use.

## ELEMENT IQ®

The Breville Smart Oven® Pro features Element IQ®, a cooking technology that adjusts the power of the heating elements to cook food more evenly and quickly. Each of the oven's functions is preset with our recommended setting, however we suggest experimenting with these depending on the recipe, amount of food and your personal taste.

Your customised setting will remain in the memory of the oven until changed or the oven is unplugged from the power outlet.

## OVEN FUNCTIONS OVERVIEW

FUNCTION	RACK POSITION	OPTIONAL SETTINGS	PRESETS	PREHEAT	RANGE
<b>GRILL</b>	Top	TEMPERATURE CONVERSION	HI 10 MINS	No	HI, MED, LO Up to 20 MINS
<b>TOAST</b>	Middle	FROZEN FOODS	Darkness 4 Slices 4	No	Darkness 1-7 Slices 1-6
<b>CRUMPET</b>	Middle	FROZEN FOODS	Darkness 4 Slices 4	No	Darkness 1-7 Slices 1-6
<b>BAKE</b>	Bottom	CONVECTION TEMPERATURE CONVERSION	160°C CONVECTION 30 MINS	Yes	50°C-230°C Up to 10:00 HRS
<b>ROAST</b>	Bottom	CONVECTION TEMPERATURE CONVERSION	175°C CONVECTION 1:00 HRS	Yes	50°C-230°C Up to 10:00 HRS
<b>PIZZA</b>	Middle	CONVECTION TEMPERATURE CONVERSION FROZEN FOODS	210°C CONVECTION FROZEN FOODS 20 MINS	Yes	50°C-230°C Up to 2:00 HRS
<b>COOKIES</b>	Middle	CONVECTION TEMPERATURE CONVERSION FROZEN FOODS	175°C CONVECTION 11 MINS	Yes	50°C-230°C Up to 1:00 HRS
<b>REHEAT</b>	Bottom	CONVECTION TEMPERATURE CONVERSION	165°C CONVECTION 15 MINS	No	50°C-230°C Up to 2:00 HRS
<b>WARM</b>	Bottom	CONVECTION TEMPERATURE CONVERSION	70°C 1:00 HRS	No	50°C-230°C Up to 2:00 HRS
<b>SLOW COOK</b>	Bottom	CONVECTION	HI CONVECTION 4:00 HRS	Yes	HI, 4:00 - 6:00 HRS LO, 8:00 - 10:00 HRS Automatic KEEP WARM Up to 2:00 HRS



## Functions

### OPERATING YOUR OVEN

1. Position the wire rack so the spokes face upward and insert it into the desired rack position. The rack positions are conveniently printed on the right-hand side of the oven door window.

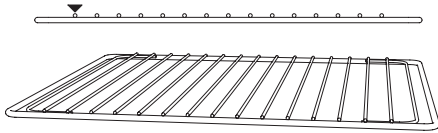

2. Turn the FUNCTION dial until the indicator on the LCD screen reaches the desired setting.
3. The top figure on the LCD screen indicates the preset cooking temperature for the selected setting. For the TOAST and CRUMPET settings it indicates the darkness level. Turn the TEMPERATURE dial to the left to reduce the temperature or to the right to increase the temperature.

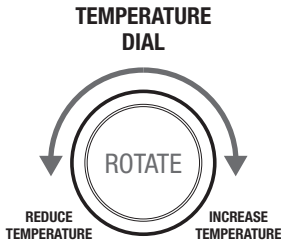

4. The bottom figure on the LCD screen indicates the preset cooking time for the selected setting. For the TOAST and CRUMPET settings it indicates the number of slices. Turn the TIME dial to the left to reduce the cooking time or to the right to increase the cooking time.

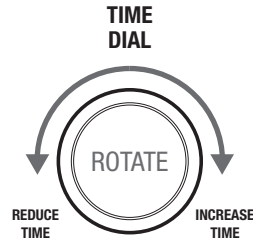

5. For settings without a preheat cycle (TOAST, CRUMPET, GRILL, REHEAT, WARM), place the food directly on the wire rack or on the included pizza pan, grilling rack and/or baking pan. Ensure the food is centered in the oven for the most even cooking.
  - a) Close the oven door.
  - b) Press the START/CANCEL button. The button backlight will illuminate red, the oven alert will sound, and the LCD screen will illuminate orange.
  - c) The timer will be displayed and begin to count down. The cooking temperature and time can be adjusted during the cooking cycle.

6. For settings that feature a preheat cycle (BAKE, ROAST, PIZZA, COOKIES, SLOW COOK), press the START/CANCEL button before placing food in the oven. The button backlight will illuminate red, the oven alert will sound and the LCD screen will indicate a blinking 'PREHEATING' while the oven is heating up.
  - a) When the oven is ready for use, the blinking 'PREHEATING' will go out, the oven alert will sound and the timer will start counting down. Place the food in the oven, either directly on the wire rack or on the included pizza pan, grilling rack and/or baking pan. Ensure the food is centered in the oven for the most even cooking.
  - b) Close the oven door.
  - c) The timer will continue to count down. The cooking temperature and time can be adjusted during the cooking cycle.
7. At the end of the cooking cycle, the oven alert will sound, the START/ CANCEL button backlight will go out and the LCD screen will illuminate blue.

### NOTE

The cooking cycle can be stopped at any time by pressing the START/ CANCEL button. This will cancel the cycle and the button backlight will go out.

### MAGNETIC AUTO-EJECT RACK

When the wire rack is inserted into the middle rack position, it will automatically eject halfway out of the oven when the door is opened so you can easily remove your toasted items.

Always open the door slowly when the wire rack is in this position to prevent the rack from ejecting too quickly.

### GRILL FUNCTION

The GRILL function is ideal for open-faced sandwiches, small cuts of meat, poultry and fish, sausages and vegetables. Grilling can also be used to brown the tops of casseroles and gratins.

1. Insert the wire rack, with the spokes facing upward, into the top rack height position.
2. Insert the included grilling rack into the baking pan. Place food on the assembled grilling rack or in an oven-proof dish, then place on the center of the wire rack so air flows around the sides of the food.
3. Close the oven door.
4. Turn the FUNCTION dial until the indicator on the LCD screen reaches the GRILL function. The top figure on the LCD screen indicates the preset grill setting of 'HI', while the bottom figure indicates the preset time of ':10 MINS'.



5. The grill setting and time can be adjusted before or during the grilling cycle.
  - a) The grill setting is displayed as the top figure on the LCD screen. Turn the TEMPERATURE dial to adjust grilling to one of three pre-set temperatures: LO, MED or HI.
  - b) The grilling time is displayed as the bottom figure on the LCD screen. Turn the TIME dial to adjust the time up to 20 minutes.
6. Press the START/CANCEL button to activate the GRILL function. The button backlight will illuminate red, the oven alert will sound and the LCD screen will illuminate orange.

- The timer will be displayed and automatically begin to count down. The temperature and time can be adjusted during the grilling cycle by turning the corresponding TEMPERATURE and TIME dial. The cycle can be stopped at any time by pressing the START/CANCEL button.
- At the end of the GRILL cycle, the oven alert will sound. The START/CANCEL button backlight will go out and the LCD screen will illuminate blue.

## TOAST FUNCTION

The TOAST function browns and crisps the outside of your bread while keeping the inside soft and moist. This function is also ideal for English muffins and frozen waffles.

- Insert the wire rack, with the spokes facing upward, into the middle rack height position.
- If toasting 1-3 slices, center the slices on the wire rack. If toasting 4-6 slices, evenly space them with 2-3 slices at the front of the wire rack and 2-3 slices at the back of the rack.
- Close the oven door.
- Turn the FUNCTION dial until the indicator on the LCD screen reaches the TOAST function. The top figure on the LCD screen indicates the preset darkness setting '4', while the bottom figure indicates the preset number of slices '4'.

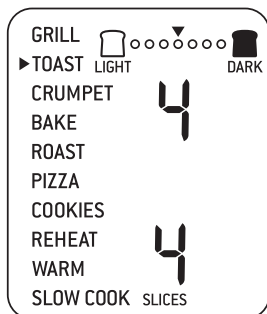

- The darkness setting and number of slices can be adjusted before or during the toasting cycle.
  - The darkness setting is indicated by the row of circles at the top of the LCD screen. Turn the TEMPERATURE dial to the left to reduce the darkness setting, or to the right to increase it. The triangle above the circles will move according to the selected setting.

As a general guide:

DESIRED TOAST COLOUR	SETTING
Light	1 or 2
Medium	3, 4 or 5
Dark	6 or 7

- The number of slices is displayed as the bottom figure on the LCD screen. Turn the TIME dial to the left to reduce the number of slices, or to the right to increase it. The number of slices ranges from '1' to '6'.
- Press the START/CANCEL button to start the TOAST function. The button backlight will illuminate red, the oven alert will sound, and the LCD screen will illuminate orange.
  - The timer will be displayed and automatically begin to count down. The time can be adjusted during the toasting cycle by turning the TIME dial. The cycle can be stopped at any time by pressing the START/CANCEL button.

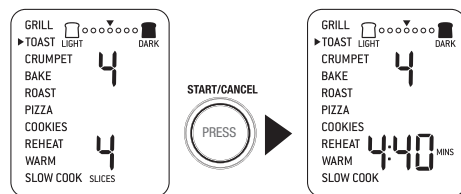

- At the end of the TOAST cycle, the oven alert will sound. The START/CANCEL button backlight will go out and the LCD screen will illuminate blue.

## CRUMPET FUNCTION

The CRUMPET function crisps the top of your crumpet while only lightly toasting the base. This function is also ideal for toasting bagels or thick sliced specialty breads which require one side to be toasted more than the other.

1. Insert the wire rack, with the spokes facing upward, into the middle rack height position.
2. If toasting 1-3 crumpets, center on the wire rack. If toasting 4-6 crumpets, evenly space them with 2-3 crumpets at the front of the wire rack and 2-3 crumpets at the back of the rack.



### NOTE

The top of the crumpet must always face upwards towards the top heating elements. This allows the top to get crisp while the base is only lightly toasted.

3. Close the oven door.
4. Turn the FUNCTION dial until the indicator on the LCD screen reaches the CRUMPET function. The top figure on the LCD screen indicates the preset darkness setting '4', while the bottom figure indicates the preset number of crumpets '4'.



### NOTE

If you like your crumpets equally crisp on both the top and bottom, we recommend using the TOAST function.

5. The darkness setting and number of crumpets can be adjusted before or during the toasting cycle.
  - a) The darkness setting is indicated by the row of triangles at the top of the LCD screen. Turn the TEMPERATURE dial to the left to reduce the darkness setting, or to the right to increase it. The circle below the triangles will move according to the selected setting.

### As a general guide:

DESIRED CRUMPET COLOUR	SETTING
Light	1 or 2
Medium	3, 4 or 5
Dark	6 or 7

- b) The number of crumpets is displayed as the bottom figure on the LCD screen. Turn the TIME dial to the left to reduce the number of crumpets, or to the right to increase it. The number of crumpets ranges from '1' to '6'.
6. Press the START/CANCEL button to start the CRUMPET function. The button backlight will illuminate red, the oven alert will sound, and the LCD screen will illuminate orange.
  7. The timer will be displayed and automatically begin to count down. The time can be adjusted during the crumpet cycle by turning the TIME dial. The cycle can be stopped at any time by pressing the START/CANCEL button.

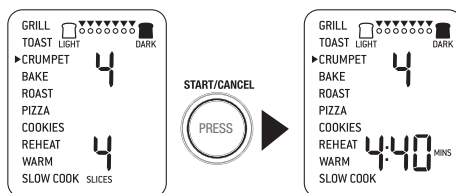

8. At the end of the CRUMPET cycle, the oven alert will sound. The START/CANCEL button backlight will go out and the LCD screen will illuminate blue.

## BAKE FUNCTION

The BAKE function cooks food evenly throughout. This function is ideal for baking cakes, muffins, brownies and pastries. The BAKE function is also ideal for cooking pre-packaged frozen meals such as lasagna and pot pies.

1. Insert the wire rack, with the spokes facing upward, into the bottom rack height position. Note that some baked goods, such as brownies or pastries, may be more suited to the middle rack height position.
2. Close the oven door.
3. Turn the FUNCTION dial until the indicator on the LCD screen reaches the BAKE function. The top figure on the LCD screen indicates the preset BAKE temperature of 160°C, while the bottom figure indicates the preset time of '30 MINS'. The preset CONVECTION setting will also be displayed.



4. The baking temperature and time can be adjusted before or during the baking cycle.
  - a) The baking temperature is displayed as the top figure on the LCD screen. Turn the TEMPERATURE dial to adjust the baking temperature from 50°C/120°F to a maximum of 230°C/450°F.
  - b) The baking time is displayed as the bottom figure on the LCD screen. Turn the TIME dial to select up to 2 hours for temperatures above 150°C/300°F and up to 10 hours for temperatures below 150°C/300°F.

5. Press the START/CANCEL button to activate the BAKE function. The button backlight will illuminate red, the oven alert will sound and the LCD screen will illuminate orange. The LCD screen will indicate a blinking 'PREHEATING'.
6. Once the oven has reached the set temperature, the temperature alert will sound.
7. Place food, positioned on the included baking pan or other oven-proof dish, on the center of the wire rack so air will flow around all sides of the food.
8. After the PREHEATING alert has sounded, the timer will automatically begin to count down. The temperature and time can be adjusted during the baking cycle by turning the corresponding TEMPERATURE and TIME dial. The cycle can be stopped at any time by pressing the START/CANCEL button.

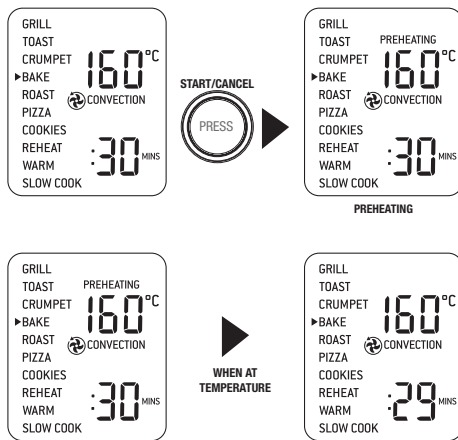

9. At the end of the BAKE cycle, the oven alert will sound. The START/CANCEL button backlight will go out and the LCD screen will illuminate blue.



## ROAST FUNCTION

The ROAST function is ideal for cooking a variety of meats and poultry. Food will be tender and juicy on the inside and roasted to perfection on the outside.

1. Insert the wire rack, with the spokes facing upward, into the bottom rack height position.
2. Close the oven door.
3. Turn the FUNCTION dial until the indicator on the LCD screen reaches the ROAST function. The top figure on the LCD screen indicates the preset ROAST temperature of 175°C, while the bottom figure indicates the preset time of '1:00HRS'. The preset CONVECTION setting will also be displayed.



4. The roasting temperature and time can be adjusted before or during the roasting cycle.
  - a) The roasting temperature is displayed as the top figure on the LCD screen. Turn the TEMPERATURE dial to adjust the baking temperature from 50°C/120°F to a maximum of 230°C/450°F.
  - b) The roasting time is displayed as the bottom figure on the LCD screen. Turn the TIME dial to select up to 2 hours for temperatures above 150°C/300°F and up to 10 hours for temperatures below 150°C/300°F.

5. Press the START/CANCEL button to activate the ROAST function. The button backlight will illuminate red, the oven alert will sound and the LCD screen will illuminate orange. The LCD screen will indicate a blinking 'PREHEATING'.
6. Once the oven has reached the set temperature, the temperature alert will sound.
7. Place food, positioned on the included baking pan or other oven-proof dish, on the center of the wire rack so air will flow around all sides of the food.
8. After the PREHEATING alert has sounded, the timer will automatically begin to count down. The temperature and time can be adjusted during the roasting cycle by turning the corresponding TEMPERATURE and TIME dial. The cycle can be stopped at any time by pressing the START/CANCEL button.

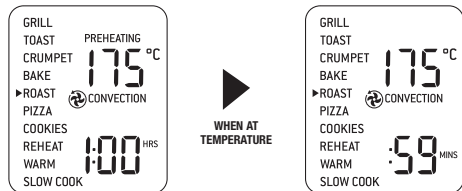
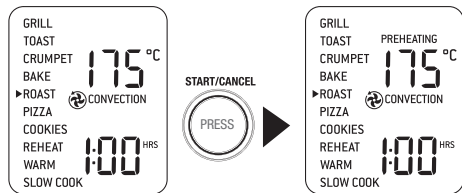

9. At the end of the ROAST cycle, the oven alert will sound. The START/CANCEL button backlight will go out and the LCD screen will illuminate blue.

## PIZZA FUNCTION

The PIZZA function melts and browns cheese and toppings, while crisping up the pizza crust.

1. Insert the wire rack, with the spokes facing upward, into the middle rack height position.
2. Close the oven door.
3. Turn the FUNCTION dial until the indicator on the LCD screen reaches the PIZZA function. The top figure on the LCD screen indicates the preset PIZZA temperature of '210°C', while the bottom figure indicates the preset time of '20 MINS'. The preset CONVECTION and FROZEN settings will also be displayed.



4. The pizza temperature and time can be adjusted before or during the cycle.
  - a) The pizza temperature is displayed as the top figure on the LCD screen. Turn the TEMPERATURE dial to adjust the baking temperature from 50°C/120°F to a maximum of 230°C/450°F.
  - b) The pizza time is displayed as the bottom figure on the LCD screen. Turn the TIME dial to adjust the time up to 2 hours.

5. Press the START/CANCEL button to activate the PIZZA function. The button backlight will illuminate red, the oven alert will sound and the LCD screen will illuminate orange. The LCD screen will indicate a blinking 'PREHEATING'.
6. Once the oven has reached the set temperature, the temperature alert will sound.
7. Place food, positioned on the included pizza pan, on the center of the wire rack so air will flow around all sides of the food.
8. After the PREHEATING alert has sounded, the timer will automatically begin to count down. The temperature and time can be adjusted during the cycle by turning the corresponding TEMPERATURE and TIME dial. The cycle can be stopped at any time by pressing the START/CANCEL button.

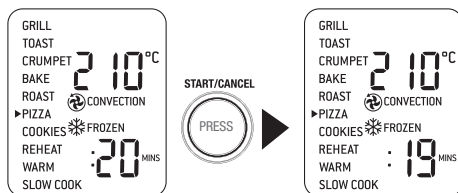

9. At the end of the PIZZA cycle, the oven alert will sound. The START/CANCEL button backlight will go out and the LCD screen will illuminate blue.

### A note on pizza stones

When using a pizza stone, it is necessary to first heat the stone (without a pizza) for optimum results.

1. Insert the wire rack, with the spokes facing upward, into the middle rack height position.
2. Place pizza stone on the center of the wire rack so air will flow around all sides of the stone.
3. Close the door.
4. Turn the TIME dial to the left to reduce the time to ':15 MINS'. The time is displayed as the bottom figure on the LCD screen. The preset CONVECTION and FROZEN settings will also be displayed.
5. Press the START/CANCEL button to activate the PIZZA function. The button backlight will illuminate red, the oven alert will sound and the LCD screen will illuminate orange. The LCD screen will indicate a blinking 'PREHEATING'.
6. Once the oven has reached the set temperature, the temperature alert will sound.
7. After the PREHEATING alert has sounded, the timer will automatically begin to count down.
8. At the end of the cycle, the oven alert will sound. The START/CANCEL button backlight will go out and the LCD screen will illuminate blue.
9. Open the oven door and carefully place frozen pizza on the heated pizza stone. When cooking fresh pizza, carefully remove the entire wire rack with pizza stone using insulated oven mitts. Place on the counter and transfer the fresh pizza dough onto the heated stone before placing back into the oven.
10. Select desired PIZZA setting and press the START/CANCEL button to re-start the PIZZA cycle.

### COOKIES FUNCTION

The COOKIES function is ideal for baking homemade or commercially prepared cookies and other baked treats.

Ready-to-bake crescent rolls, cinnamon scrolls, biscuits and strudels are ideally baked using this function.

1. Insert the wire rack, with the spokes facing upward, into the middle rack height position.
2. Close the oven door.
3. Turn the FUNCTION dial until the indicator on the LCD screen reaches the COOKIES function. The top figure on the LCD screen indicates the preset temperature of 175°C, while the bottom figure indicates the preset time of ':11 MINS'. The preset CONVECTION setting will also be displayed.



4. The baking temperature and time can be adjusted before or during the cookie cycle.
  - a) The baking temperature is displayed as the top figure on the LCD screen. Turn the TEMPERATURE dial to adjust the baking temperature from 50°C/120°F to a maximum of 230°C/450°F.
  - b) The baking time is displayed as the bottom figure on the LCD screen. Turn the TIME dial to adjust the time up to 1 hour.

5. Press the START/CANCEL button to activate the COOKIES function. The button backlight will illuminate red, the oven alert will sound and the LCD screen will illuminate orange. The LCD screen will indicate a blinking 'PREHEATING'.
6. Once the oven has reached the set temperature, the temperature alert will sound.
7. Place food, positioned on the included baking pan, pizza pan or other oven-proof dish, on the center of the wire rack so air will flow around all sides of the food.
8. After the PREHEATING alert has sounded, the timer will automatically begin to count down. The temperature and time can be adjusted during the cycle by turning the corresponding TEMPERATURE and TIME dial. The cycle can be stopped at any time by pressing the START/CANCEL button.
9. At the end of the COOKIES cycle, the oven alert will sound. The START/CANCEL button backlight will go out and the LCD screen will illuminate blue.

## REHEAT FUNCTION

The REHEAT function is ideal for reheating leftovers without browning.

1. Insert the wire rack, with the spokes facing upward, into the bottom rack height position.
2. Place food, positioned on the included baking pan, pizza pan or other oven-proof dish, on the center of the wire rack so air will flow around all sides of the food.
3. Close the oven door.

4. Turn the FUNCTION dial until the indicator on the LCD screen reaches the REHEAT function. The top figure on the LCD screen indicates the preset temperature of '165°C', while the bottom figure indicates the preset time of '15 MINS'. The preset CONVECTION setting will also be displayed.



5. The reheating temperature and time can be adjusted before or during the reheating cycle.
  - a) The temperature is displayed as the top figure on the LCD screen. Turn the TEMPERATURE dial to adjust the temperature from 50°C/120°F to a maximum of 230°C/450°F.
  - b) The time is displayed as the bottom figure on the LCD screen. Turn the TIME dial to adjust the time up to 2 hours.
6. Press the START/CANCEL button to activate the REHEAT function. The button backlight will illuminate red, the oven alert will sound and the LCD screen will illuminate orange.
7. The timer will be displayed and begin to count down. The temperature and time can be adjusted during the reheating cycle by turning the corresponding TEMPERATURE and TIME dial. The cycle can be stopped at any time by pressing the START/CANCEL button.
8. At the end of the REHEAT cycle, the oven alert will sound. The START/CANCEL button backlight will go out and the LCD screen will illuminate blue.

## WARM FUNCTION

The WARM function maintains hot foods at the recommended temperature to prevent bacterial growth (70°C/160°F or above).

1. Insert the wire rack, with the spokes facing upward, into the bottom rack height position.
2. Place food, positioned on the included baking pan, pizza pan or other oven-proof dish, on the center of the wire rack so air will flow around all sides of the food.
3. Close the oven door.
4. Turn the FUNCTION dial until the indicator on the LCD screen reaches the WARM function. The top figure on the LCD screen indicates the preset temperature of '70°C', while the bottom figure indicates the preset time of '1:00 HRS'. The preset KEEP WARM symbol will also be displayed.



5. The warming temperature and time can be adjusted before or during the warming cycle.
  - a) The temperature is displayed as the top figure on the LCD screen. Turn the TEMPERATURE dial to adjust the temperature from 50°C/120°F to a maximum of 230°C/450°F.
  - b) The time is displayed as the bottom figure on the LCD screen. Turn the TIME dial to adjust the time up to 2 hours.
6. Press the START/CANCEL button to activate the WARM function. The button backlight will illuminate red, the oven alert will sound and the LCD screen will

illuminate orange.

7. The timer will be displayed and automatically begin to count down. The temperature and time can be adjusted during the warming cycle by turning the corresponding TEMPERATURE and TIME dial. The cycle can be stopped at any time by pressing the START/CANCEL button.
8. At the end of the WARM cycle, the oven alert will sound. The START/CANCEL button backlight will go out and the LCD screen will illuminate blue.

## SLOW COOK FUNCTION

The SLOW COOK function has cooking profiles designed for long cook times at low temperatures.

1. Insert the wire rack, with the spokes facing upward, into the bottom rack height position.
2. Close the oven door.
3. Turn the FUNCTION dial until the indicator on the LCD screen reaches the SLOW COOK function. The top figure on the LCD screen indicates the preset SLOW COOK setting of 'HI', while the bottom figure indicates the preset time of '4:00 HRS'. The preset CONVECTION setting will also be displayed.



4. The slow cook setting and time can be adjusted:
  - a) The slow cook setting is displayed as the top figure on the LCD screen. Turn the TEMPERATURE dial to adjust slow cooking to one of two preset temperatures: 'LO' or 'HI'.
  - b) The time is displayed as the bottom figure on the LCD screen. Turn the TIME dial to adjust the time between 8 and 10 hours for 'LO' and between 4 and 6 hours for 'HI'.
5. Press the START/CANCEL button to activate the SLOW COOK function. The button backlight will illuminate red, the oven alert will sound and the LCD screen will illuminate orange. The LCD screen will indicate a blinking 'PREHEATING'.
6. Once the oven has reached the set temperature, the temperature alert will sound.
7. Place food, inside oven-proof cookware, on the center of the wire rack so air will flow around all sides of the food.
8. After the PREHEATING alert has sounded, the timer will automatically begin to count down. Time can be adjusted during the slow cook cycle by turning the corresponding TIME dial. The cycle can be stopped at any time by pressing the START/CANCEL button.
9. At the end of the SLOW COOK cycle, the oven will automatically switch to the WARM function. The LCD screen will display 'KEEP WARM' and the maximum keep warm time of '2:00 HRS' will automatically count down. The keep warm cycle can be stopped at any time by pressing the START/CANCEL button.



#### NOTE

Do not pull the wire rack further than halfway out when inserting or removing the cookware from the oven.

#### Tips for slow cooking

1. Ensure cookware is ovenproof and does not exceed 6 kg when empty.
2. Fill cookware to minimum  $\frac{1}{2}$  and maximum  $\frac{3}{4}$  full to avoid over or under-cooking. To prevent spillover, do not fill cookware more than  $\frac{3}{4}$  full.
3. Always slow cook with the lid on to prevent food from drying out. Cover cookware with a layer of aluminum foil before covering with lid to keep even more moisture in.
4. Follow cooking settings and times prescribed in traditional slow cooker recipes. One hour on 'HI' is equivalent to approximately one-and-a-half to two hours on 'LO'.
5. Cold food will take longer to cook than food that has been pre-seared or heated so adjust cooking times as appropriate. Do not slow cook frozen foods.

#### USING THE WARMING TRAY

The top of the oven is very hot during and after operation. As a result, storing items on top of the oven is not recommended.

The only exception is the optional Breville Bamboo Cutting Board and Serving Tray that fits in the ribbed section on top of the oven.

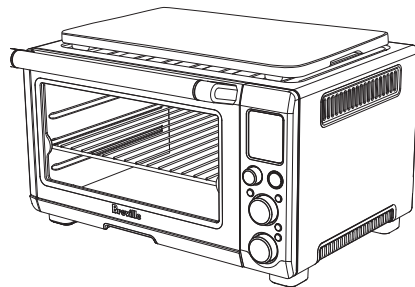

## REPLACING THE OVEN LIGHT



### WARNING

Always unplug oven and let cool before replacing bulb. Only use a 25-Watt, 220-240V, G9 type oven bulb.

1. Remove the wire rack from the oven before replacing the light.
2. The light is positioned on the left-hand side of the oven cavity. Position your fingers on the outside of the light housing and gently pull the glass cover away from the oven wall to remove it. If you are unable to pull the cover off, slide a spoon into the left side of the light housing and gently lever the glass cover off. Always hold the glass cover with the other hand to prevent the cover from falling and breaking.
4. Use a soft cloth to insert the new bulb. Do not directly touch the surface of the bulb with your fingers as oil from your skin can damage the bulb.

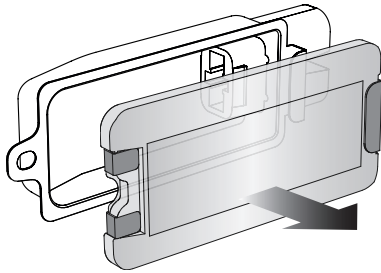
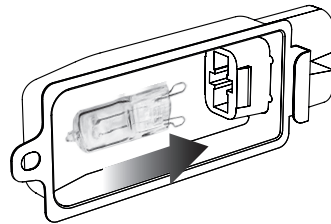

3. Remove the used bulb by pulling it directly out of its holder.

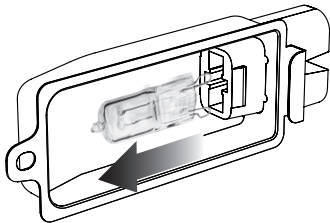

5. To reattach the glass cover, align the metal hook with the left side of the light housing. Slide the opposite end of the glass cover into the metal bracket on the right side of the housing, then push the metal hook into the left side of the housing until it snaps securely into position.

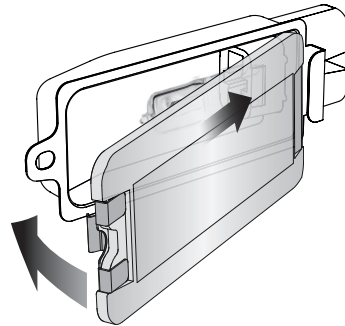



## Care & Cleaning

Before cleaning, ensure the oven is turned off by pressing the START/CANCEL button on the control panel. The oven is off when the button backlight is no longer illuminated.

Remove the power plug from the power outlet. Allow the oven and all accessories to cool completely before disassembling and cleaning.

### CLEANING THE OUTER BODY AND DOOR

1. Wipe the outer body with a soft, damp sponge. A non-abrasive liquid cleanser or mild spray solution may be used to avoid build-up of stains. Apply the cleanser to the sponge, not the oven surface, before cleaning.
2. To clean the glass door, use a glass cleaner or mild detergent and a soft, damp sponge or soft plastic scouring pad. Do not use an abrasive cleanser or metal scouring pad as these will scratch the oven surface.
3. Wipe the LCD screen with a soft damp cloth. Apply cleanser to the cloth and not the LCD surface. Cleaning with dry cloth or abrasive cleaners may scratch the surface.
4. Let all surfaces dry thoroughly prior to inserting the power plug into a power outlet and turning the oven on.



#### WARNING

Do not immerse the body, power cord or power plug in water or any other liquid as this may cause electrocution.

### CLEANING THE INTERIOR

1. The walls on the inside of the oven feature a non-stick coating for easy cleaning. To clean any spattering that may occur while cooking, wipe the walls with a soft, damp sponge. A non-abrasive liquid cleanser or mild spray solution may be used to avoid build-up of stains. Apply the cleanser to the sponge, not the oven surface, before cleaning. Avoid touching the quartz heating elements.



#### WARNING

Use extreme caution when cleaning the quartz heating elements. Allow the oven to cool completely, then gently rub a soft, damp sponge or cloth along the length of the heating element. Do not use any type of cleanser or cleaning agent. Let all surfaces dry thoroughly prior to inserting the power plug into a power outlet and turning the oven on.

2. Let all surfaces dry thoroughly prior to inserting the power plug into a power outlet and turning the oven on.

### CLEANING THE CRUMB TRAY

1. After each use, slide out the crumb tray and discard crumbs. Wipe the tray with a soft, damp sponge. A non-abrasive liquid cleanser may be used to avoid build-up of stains. Apply the cleanser to the sponge, not the tray, before cleaning. Dry thoroughly.
2. To remove baked-on grease, soak the tray in warm soapy water then wash with a soft sponge or soft plastic scouring pad. Rinse and dry thoroughly.
3. Always ensure to re-insert the crumb tray into the oven after cleaning and prior to inserting the power plug into a power outlet and turning the oven on.



## **CLEANING THE WIRE RACK, GRILLING RACK, BAKING PAN AND PIZZA PAN**

1. Wash all accessories in warm soapy water with a soft sponge or soft plastic scouring pad. Rinse and dry thoroughly. Do not use abrasive cleansers, metal scouring pads or metal utensils to clean any of the accessories as they may damage the surfaces.
2. To extend the life of your accessories, we do not recommend that these be placed in the dishwasher.

## **STORAGE**

1. Ensure the oven is turned off by pressing the START/CANCEL button on the control panel. The oven is off when the button backlight is no longer illuminated.
2. Remove the power plug from the power outlet. Allow the oven and all accessories to cool completely before disassembling and cleaning
3. Ensure the oven and all accessories are clean and dry.
4. Ensure the crumb tray is inserted into the oven; the grilling rack is inserted into the baking pan and resting on the wire rack in the middle rack height position.
5. Ensure the door is closed.
6. Store the appliance in an upright position standing level on its support legs. Do not store anything on top. The only exception is the optional Breville Bamboo Cutting Board and Serving Tray.



## Troubleshooting

POSSIBLE PROBLEM	EASY SOLUTION
Oven will not switch "ON".	<ul style="list-style-type: none"><li>• Check that the power plug is securely inserted into the outlet.</li><li>• Insert the power plug into an independent outlet.</li><li>• Insert the power plug into a different outlet.</li><li>• Reset the circuit breaker if necessary.</li></ul>
I would like to have the oven LCD default settings back.	<ul style="list-style-type: none"><li>• The oven will remember the last setting used for each function unless you remove the plug from the power outlet.</li><li>• To restore the oven's default settings for each function, remove the plug from the power outlet. Wait 5 seconds, then plug back in.</li></ul>
The LCD display light has gone out.	<ul style="list-style-type: none"><li>• The oven goes into standby mode if not used for 10 minutes. When in standby mode, the LCD screen will cease to illuminate, however all function options will still be visible.</li><li>• To re-activate the oven out of standby mode, press the START/CANCEL button on the control panel, or turn any dial. The LCD screen will re-illuminate.</li></ul>
The pizza does not cook evenly.	<ul style="list-style-type: none"><li>• Some large pizzas may brown unevenly in compact ovens. Open the oven door half way through the cooking time and turn the pizza 90 degrees for more even darkness.</li></ul>
The Magnetic Auto-Rack Eject comes out too far when I open the door.	<ul style="list-style-type: none"><li>• Always open the door slowly and in a controlled manner when the wire rack is inserted into the middle rack height position to prevent the wire rack from ejecting too quickly.</li></ul>
I cannot select the FROZEN FOODS button.	<ul style="list-style-type: none"><li>• The FROZEN FOODS button is only selectable during the TOAST, CRUMPET, PIZZA and COOKIES functions.</li></ul>
Steam is coming out from the top of the oven door.	<ul style="list-style-type: none"><li>• This is normal. The door is vented to release steam created from high-moisture content foods such as frozen breads.</li></ul>
The heating elements appear to be pulsing.	<ul style="list-style-type: none"><li>• Element IQ® accurately controls the heat inside the oven by pulsing the power in the heating elements in short bursts. This is normal.</li></ul>
Water is dripping onto the bench top from under door.	<ul style="list-style-type: none"><li>• This is normal. The condensation created from high moisture content foods such as frozen breads will run down the inside of the door and can drip onto the bench top.</li></ul>
The temperature reading on the LCD screen doesn't match the temperature measured inside the oven.	<ul style="list-style-type: none"><li>• To ensure the measurements are standardized, the oven temperatures have been calibrated in the TOAST position (center of the middle rack with no tray in place). Re-check the temperature in this position, ensuring not to open the oven door for 10 minutes as heat will escape each time the door is opened. Note that the 'preheat' alert sounds at 75% of the target temperature.</li></ul>



POSSIBLE PROBLEM	EASY SOLUTION
------------------	---------------

The 'preheat' alert sounds at a lower temperature than what is displayed on the LCD screen.

- The 'preheat' alert sounds at 75% of the target temperature. This provides the fastest, combined preheating and cooking time.
- This is because when the 'preheating' alert sounds, signalling the user to open the oven door and insert food, there is dramatic temperature loss inside the oven. If the alert sounded at 100% of the target temperature, opening the door would mean a lot of this waiting time is "wasted". We have calculated that by sounding the alert at 75% of the target temperature, followed by the oven door being opened to place food inside the oven, that we still recover to the target temperature up to 2 minutes faster. This is why the temperature on the LCD screen does not match the target temperature at the 'preheat' alert. In total, it takes the oven approximately 8-10 minutes from start-up, including opening the oven door when the 'preheat' alert sounds, to reach the target temperature. To ensure the fastest heat up time, the Breville oven uses the maximum allowable power from the outlet (1500W for baking, 2400W for toasting).

The LCD screen displays 'E01'.

- The LCD screen will display 'E01' when there is a non-resettable issue with the appliance. Should this occur, immediately remove the power cord from the power outlet and call Breville Customer Service.

The LCD screen displays 'E02'.

- The LCD screen will display 'E02' when there is a non-resettable issue with the appliance. Should this occur, immediately remove the power cord from the power outlet and call Breville Customer Service.

The LCD screen displays 'E03'.

- The LCD screen will display 'E03' if the oven temperature is above the set maximum limit. Remove the plug from the power outlet, allow the oven to cool for 15 minutes, then plug back in.
- Call Breville Customer Service if the 'E03' message continues.

The LCD screen displays 'E04'.

- The LCD screen will display 'E04' if the room temperature is below the set minimum. Unplug the oven and relocate to a warmer area.

The LCD screen displays 'E05'.

- The LCD screen will display 'E05' when there is a non-resettable issue with the appliance. Should this occur, immediately remove the power cord from the power outlet and call Breville Customer Service.





# **Breville**<sup>®</sup>

Thought for food

Breville is a registered trademark of Breville Pty. Ltd. A.B.N. 98 000 092 928.  
Copyright Breville Pty. Ltd. 2016.

Due to continued product improvement, the products illustrated/photographed  
in this brochure may vary slightly from the actual product.

BOV820EX - A16